

输出端

输入端

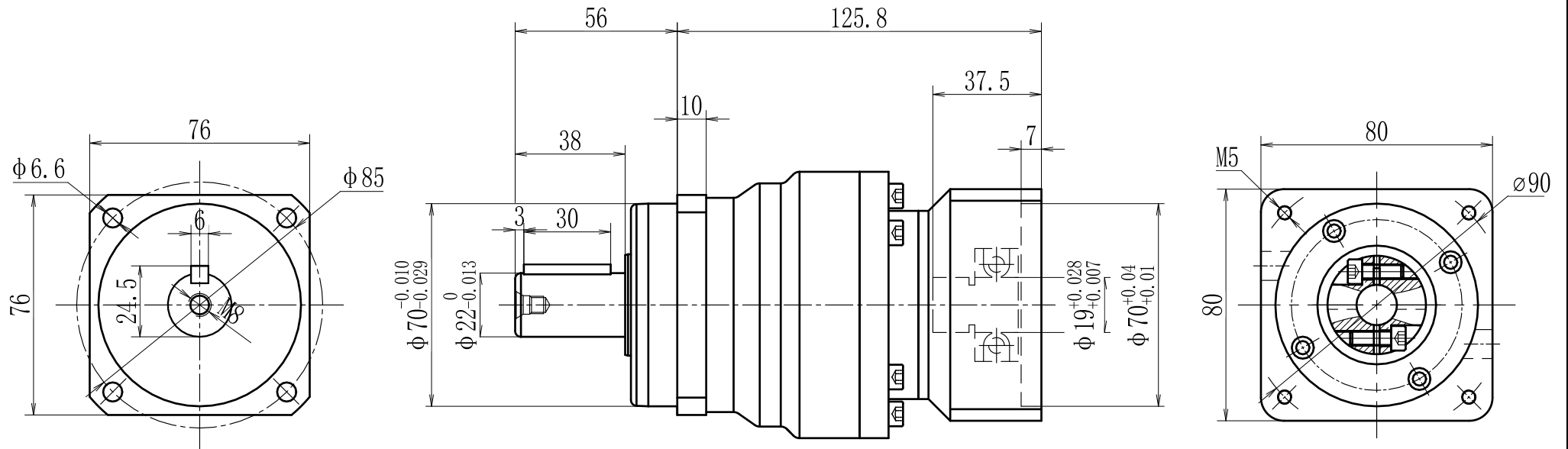

型号 model	VRS75-L2-K-6-80		
速比 ratio	1:12-1:100	承受扭矩 Bear torque	75-165Nm
背隙 precision	6arcmin	输入转速 Input speed	3000r/min
噪音 noise	55dB	重量 weight	4.2kg



帝悦精密科技(苏州)有限公司

YUE DI PRECISION TECHNOLOGY (SUZHOU) CO., LTD.

精密行星减速机
Precision planetary reducer

电话(Call): 0512-53127777
网址(http): WWW.DEU-GAM.COM